

MADE IN ITALY



For 50 years we have been passionately dedicating ourselves to producing planetary gears and wheel gears made entirely in Italy. Reggiana Riduttori is a member of Interpump Group.

SOLUTIONS FOR  
WASTE MANAGEMENT





Pag

3

D

## OUR DRIVES FOR SUSTAINABILITY

Today the environmental issue is important and urgent: with 50 years of engineering experience, **Reggiana Riduttori** - now part of Interpump Group S.p.a - provides complete transmission solutions for **materials and waste water recycling plants**. Our offer includes **planetary, rotation, winch, shaft and bevel gearboxes** to cover all application needs, optimizing plant performance and really reducing environmental impact and operating costs.

These solutions are developed with a high degree of customization, to adapt perfectly to the customer's needs.

Oggi il tema ambientale è importante ed urgente: con 50 anni di esperienza ingegneristica, **Reggiana Riduttori** - ora parte di Interpump Group S.p.a - fornisce soluzioni complete per la trasmissione di potenza negli **impianti di riciclo materiali e acque reflue**.

La nostra offerta comprende **riduttori epicicloidali, per rotazione, per argano, lineari e angolari** per coprire tutte le esigenze applicative, ottimizzando le prestazioni degli impianti e riducendone realmente impatto ambientale e costi di gestione.

Queste soluzioni sono sviluppate con un alto grado di personalizzazione, per adattarsi perfettamente alle esigenze del cliente.

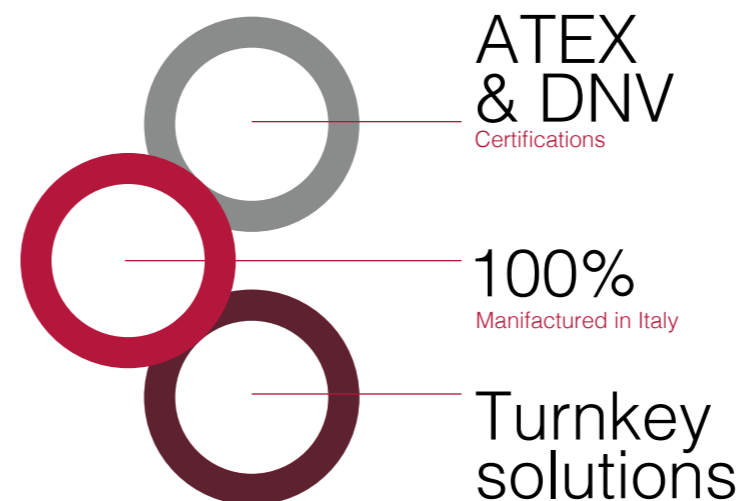

R

COMPLETE  
RANGE

## PLANETARY

**2000 SERIES | PLUS SERIES**  
Modular  
planetary  
reduction gears

**T2max Nm=1.200-10.000.000**  
**Ratio=3,4-5061**

WHEEL &  
TRACK GEARS

**RRWDI RRTD**

Compact wheel & track drives with  
single, double or triple stage.  
For hydraulic or electric traction.

**T2max Nm=1.000-50.000**  
**Ratio=5-179**

SLEWING  
& WINCH

**SLEWING SERIES**  
Gearboxes for slewing.

**T2max Nm=2.040-346.910**  
**Ratio=3,4-2500**

**W SERIES**

Winch drives.

**T2max Nm=10.000-1.100.000**  
**Ratio=12-860**

In collaborazione con

**TRANSTECNO**  
the modular gearmotor

HELICAL &  
COMBINED

Helical & bevel helical gearboxes

**T2nom Nm=2.400-130.200**  
**Helical Ratio =1,11-520,70**  
**Bevel helical Ratio =4,91-406,89**

Combined gearboxes

**T2max Nm=390.000-4.300.000**  
**Rapporti=90-600**

**V SERIES** - Combined planetary and worm speed gearboxes

**T2max Nm=1.200-26.500**  
**Ratio=324-2.765**

D

FOR SHREDDING,  
CONVEYING,  
SCREENING,  
CLARIFYING





# T

## TRASMISSIONS FOR THE WASTE MANAGEMENT

### RECYCLING PLANT

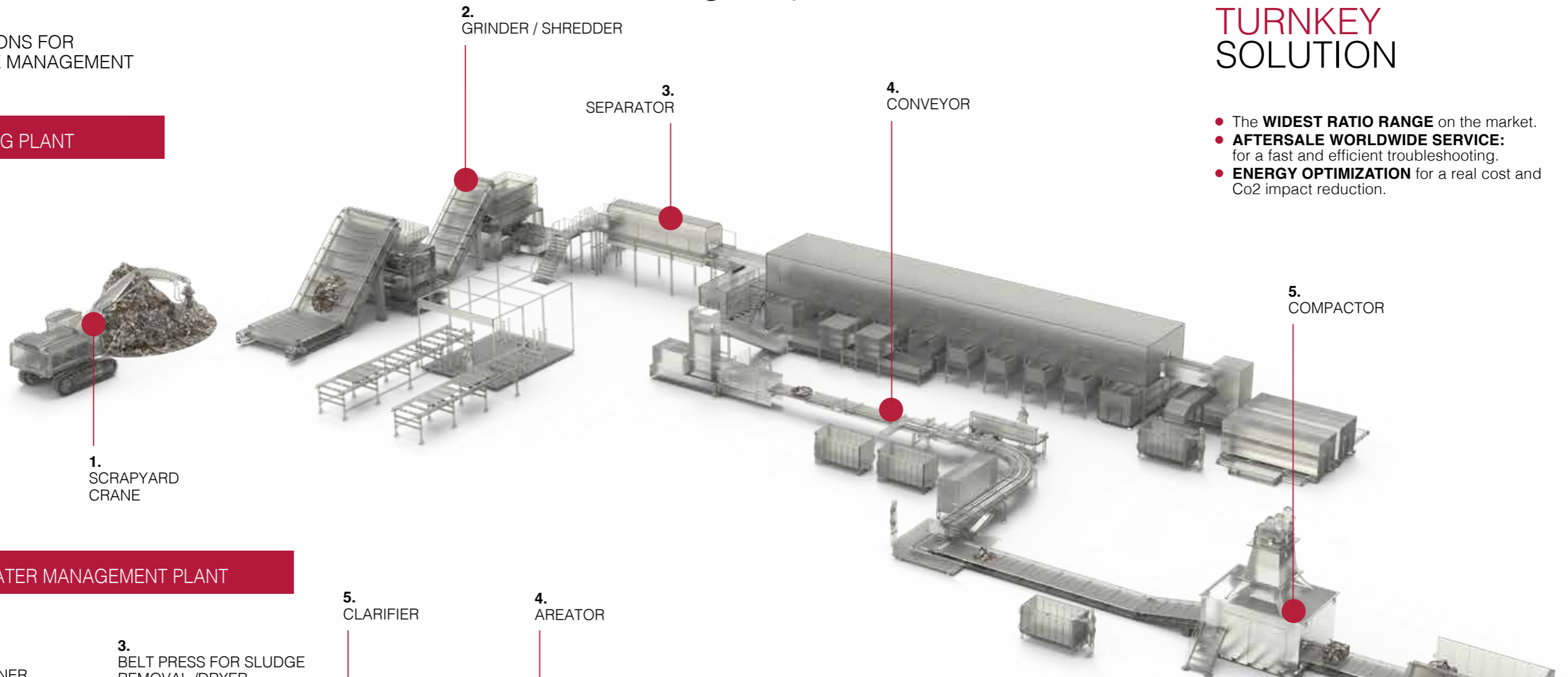

## TURNKEY SOLUTION

- The **WIDEST RATIO RANGE** on the market.
- **AFTERSALE WORLDWIDE SERVICE:** for a fast and efficient troubleshooting.
- **ENERGY OPTIMIZATION** for a real cost and Co2 impact reduction.

### WASTE WATER MANAGEMENT PLANT

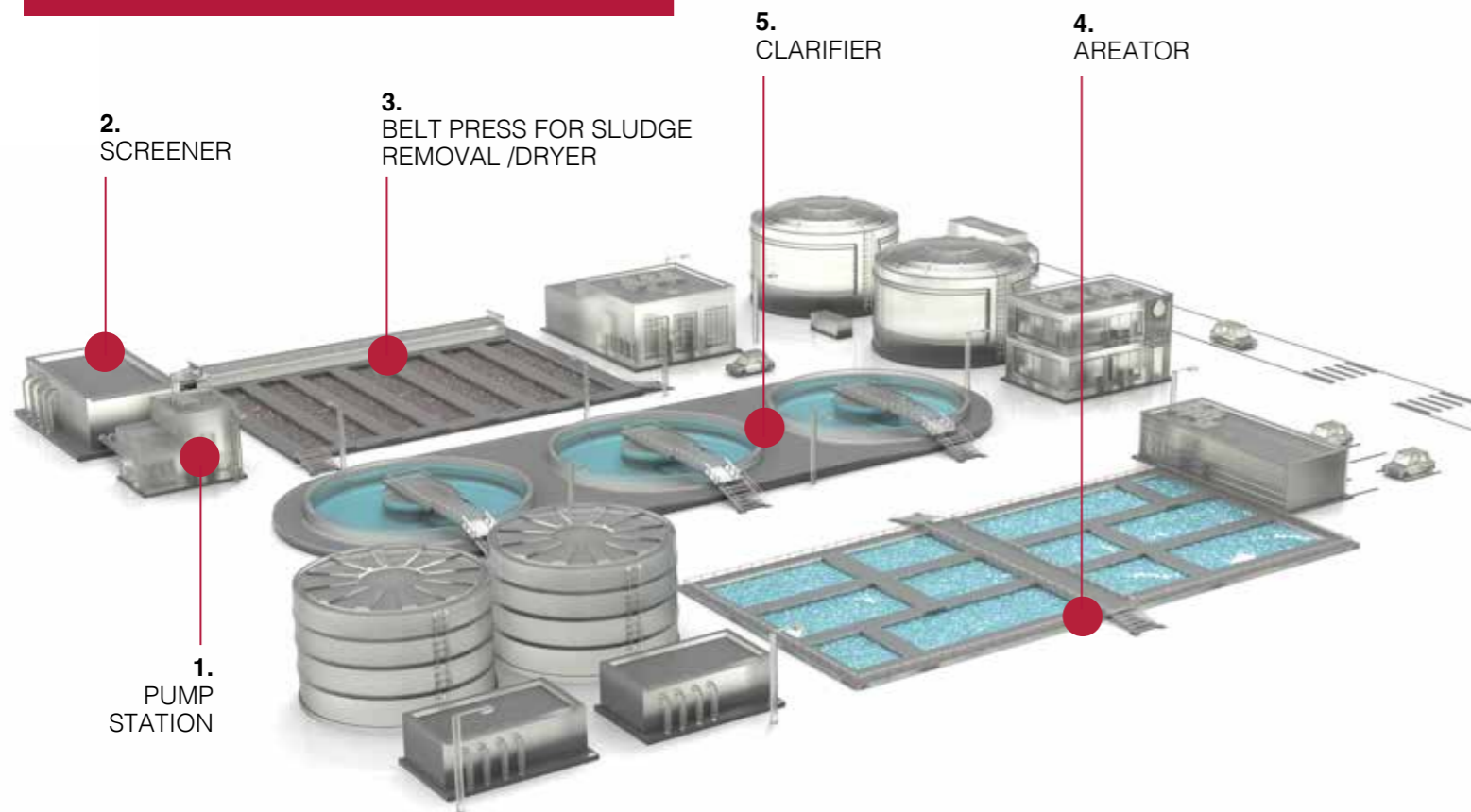

\* the electric solution reduce power consumption by around 30% compared to hydraulic one, offering the same performance quality and durability. More information available on Edrives brochure.

S

SHREDDING  
SPECIALIST

Pag

8



Pag

9

## KEY FEATURES FOR SHREDDERS

- **COMPACTNESS**
- **HIGH TORQUE RESISTANCE:** to process all kind of materials
- **RELIABLE AND EFFICIENT:** ready to work 24/7
- **HYDRAULIC OR ELECTRIC** input
- Extreme possibility of **CUSTOMIZATION**
- **LONG OPERATING LIFE**

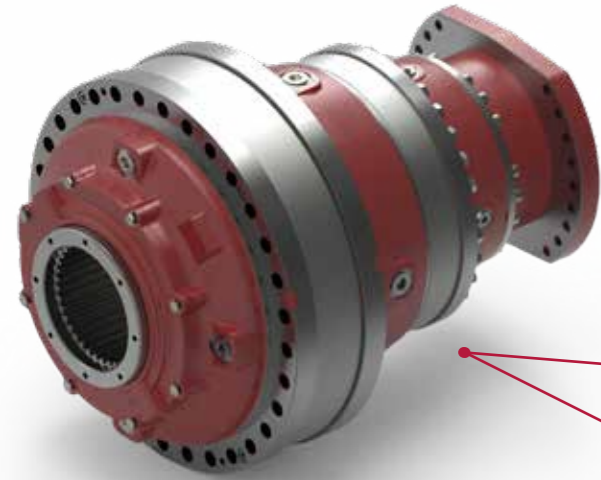
LOW  
WEIGHTHIGH  
SHREDDING  
PAYLOAD

CRUSHER

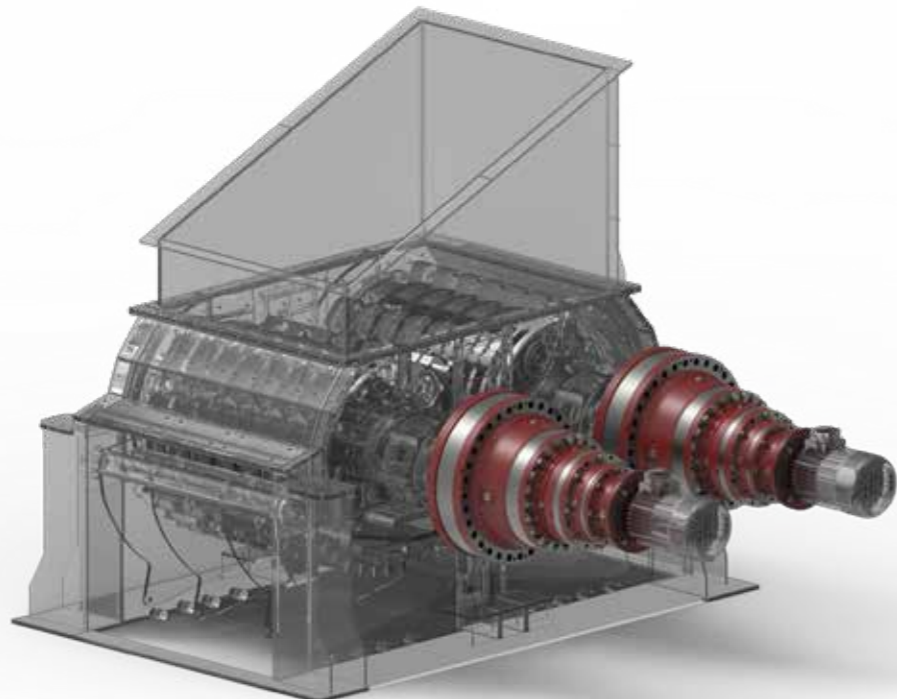

MOBILE SHREDDER



STATIONARY SHREDDER

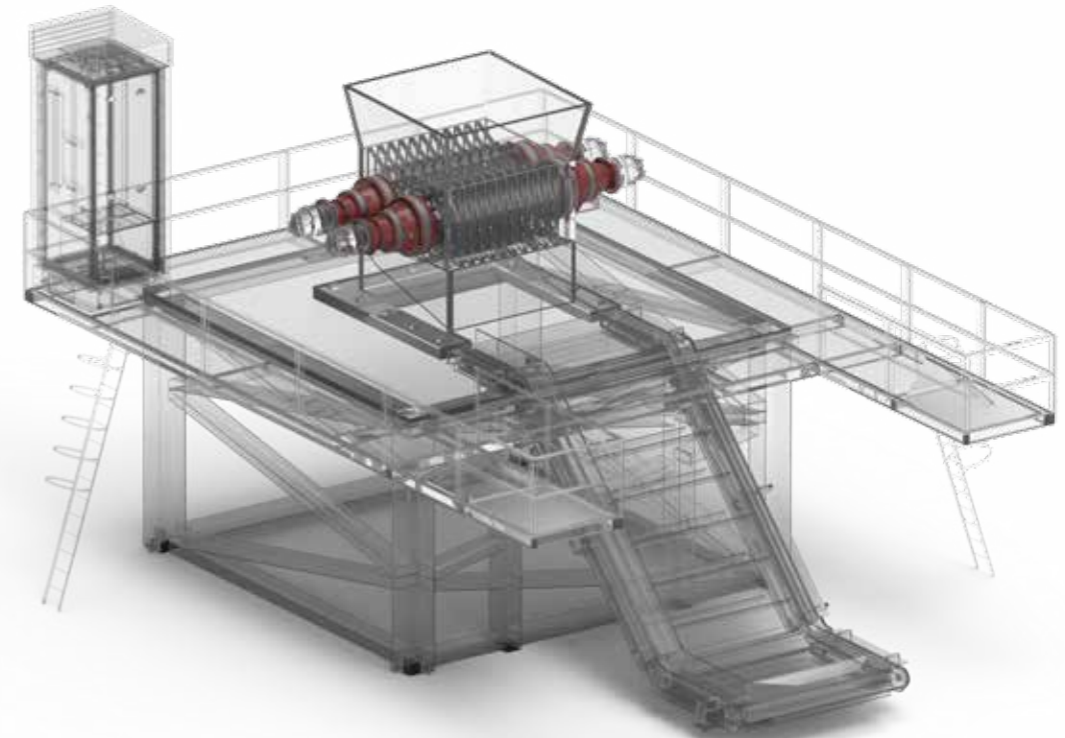



# W

WASTE  
WATER TREATMENT

## CLARIFIER

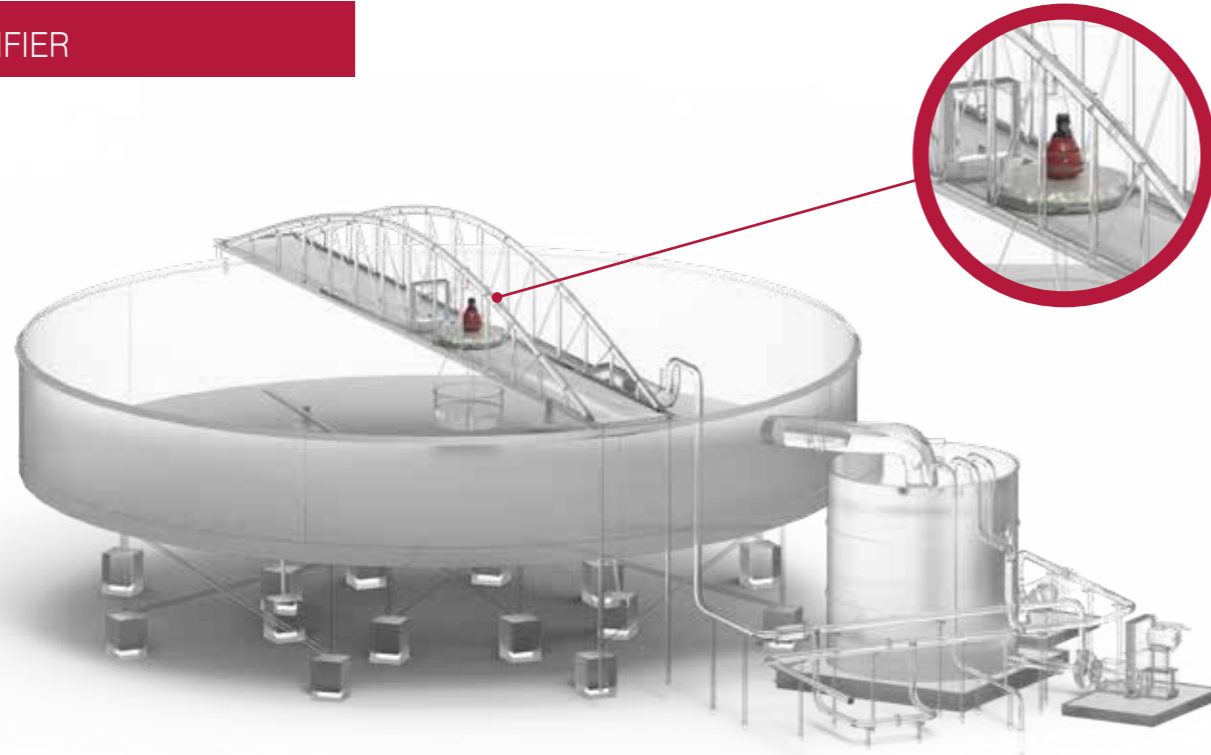

## OTHER APPLICATIONS

Please contact Reggiana Riduttori Sales Department for any further information.

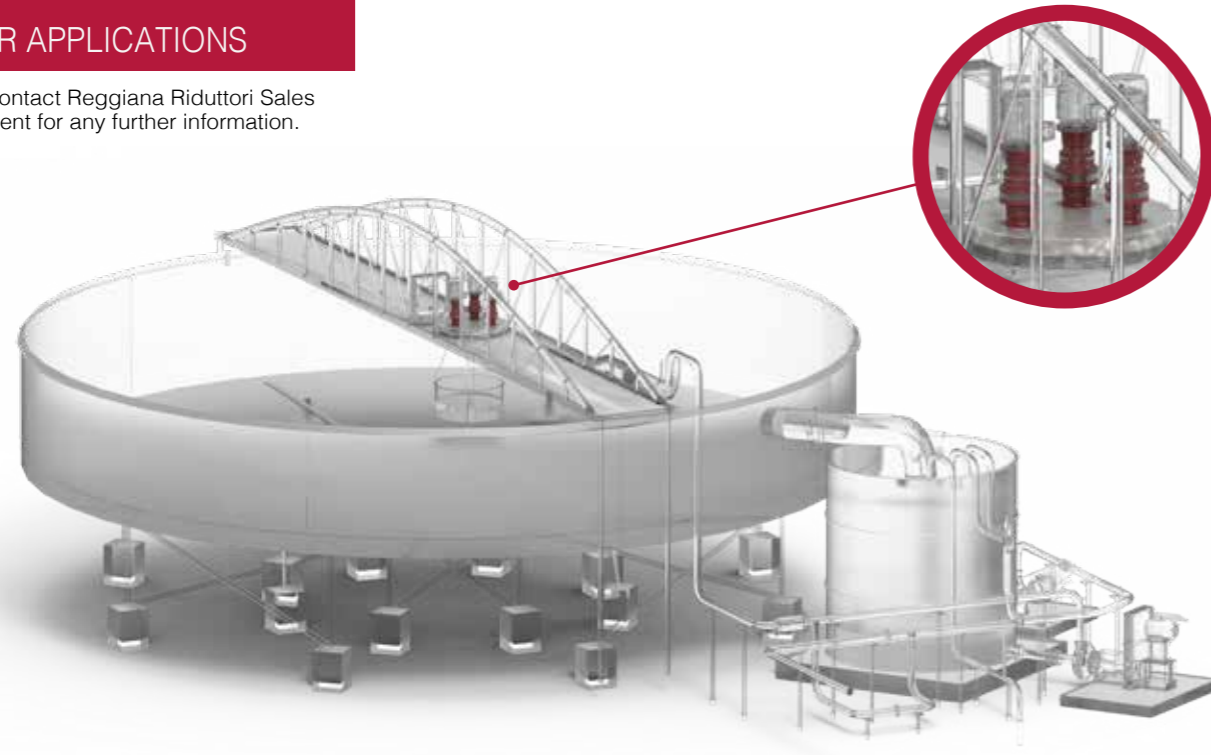

# G

## Global Sales Network

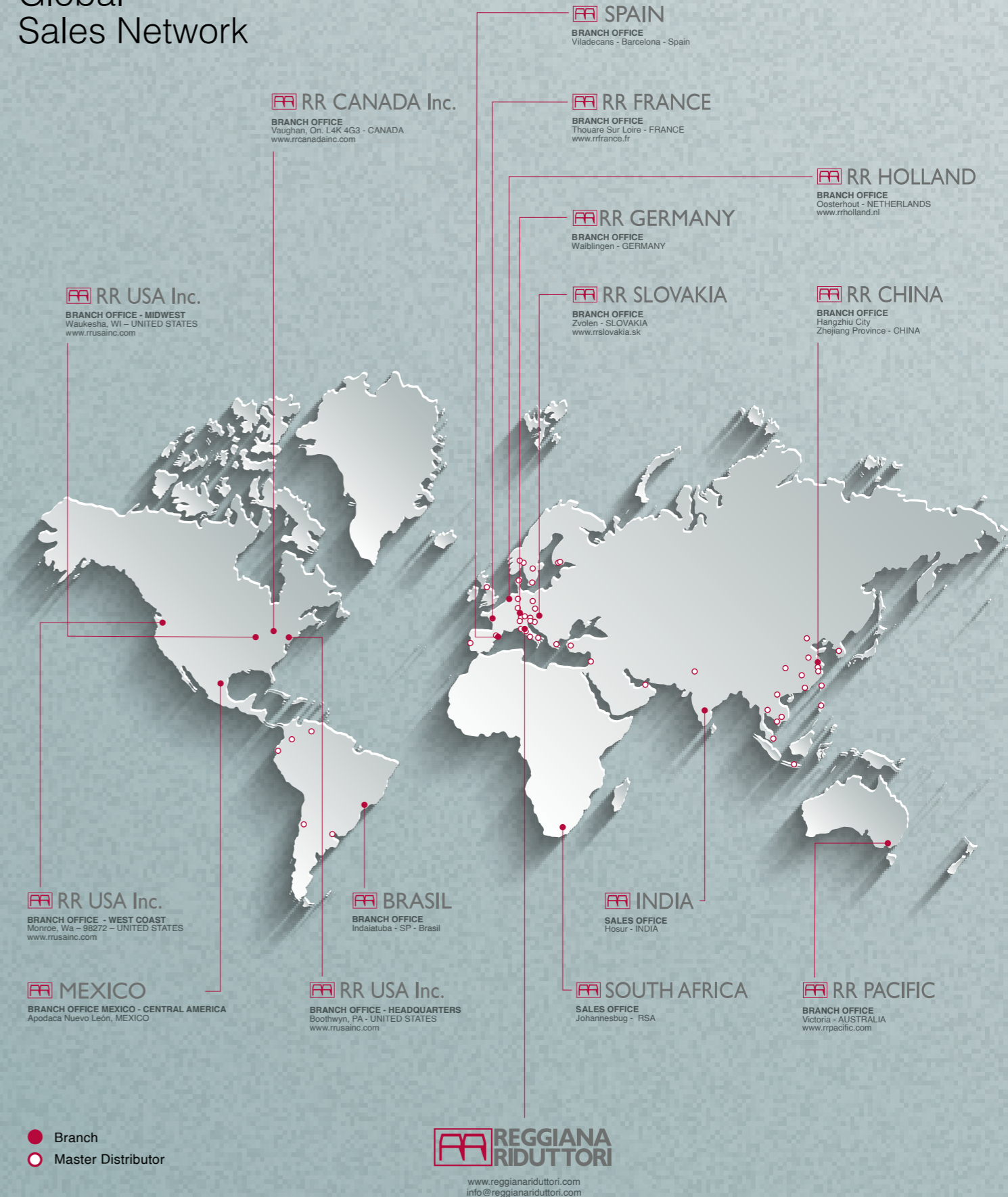



**Headquarter**

Via Martiri di Marzabotto 7  
42020 S.Polo D'Enza (RE)  
Reggio Emilia, Italy  
REGGIANARIDUTTORI.COM

Ph. +39 0522 259111  
Fax +39 0522 874321  
info@reggianariduttori.com  
PEC: reggianariduttori@legalmail.it



A member of

